

STABILUS

Swivel Chair Application



... technology gives comfort

Innovations | in seat height adjustment

Special product versions for premium swivel chair applications

Whether standard functions or special functional demands need to be fulfilled – STABILUS can provide the perfect solution for almost any need.

This brochure will give you an overview of the most important product versions for seat height adjustment.

Ergonomics and seat height

For years, ergonomics experts have been clamoring for office furniture where the correct seat height can be easily adjusted. STAB-O-MAT and STAB-O-BLOC gas springs have been designed for this purpose and offer the perfect solutions for modern seated/standing workstations.

Product characteristics

The STAB-O-MAT absorbs the weight on the seat and bending moments (caused by uneven weight distribution on the seat) with the properly designed pressure cylinder (**self-supporting**); in the STAB-O-BLOC, these tasks are performed by the internal gas spring and the additional support tube (**non self-supporting**).

They are both available with the same forces and in the same dimensions, which makes them interchangeable.

self-supporting column STAB-O-MAT

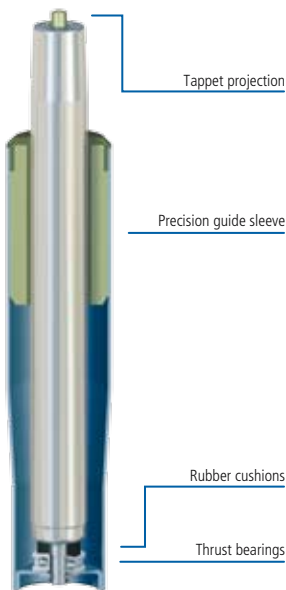

Complete column

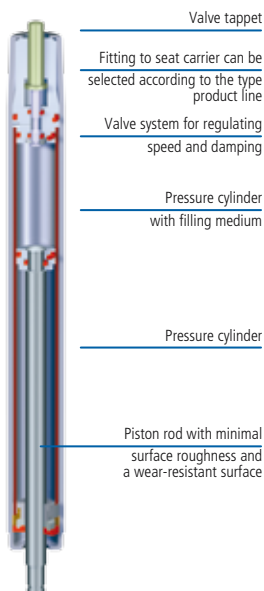

Individual gas

STAB-O-MAT / STAB-O-BLOC

| the gas springs for comfortable height adjustment

For variable seat height adjustment

STAB-O-MAT and STAB-O-BLOC gas springs are lockable gas springs specifically for variable and comfortable adjustment of the seat height in office swivel chairs, task chairs, executive chairs, stools, etc.

Occupational safety and standards

STABILUS height adjustments comply with all pertinent standards for office swivel chairs and task chairs worldwide. In certain workplaces, seating furniture must fulfill special demands. For example, the chair should not turn or roll away in the standing position. Or, the furniture must meet certain values for electrostatic discharge. The broad product line from STABILUS offers suitable solutions for all these demands. Of course, they come in the well-known STABILUS quality!

Properties and advantages

- available as complete columns or individual gas springs
- available in different lengths and with strokes of 50 to 300 mm
- rotating and swivel resistant versions
- complete columns with different outer tube versions
- telescope column with a disproportionate adjustment range
- different end position cushioning systems for more comfortable seating
- with adjustable actuation tappets
- different actuation systems
- multi-function column with return function
- column with stop function

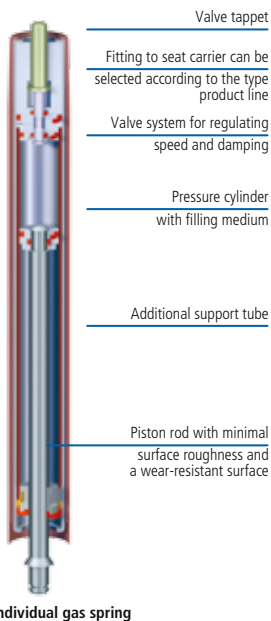
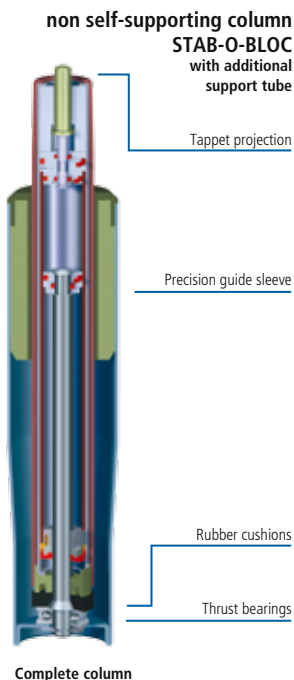

STAB-O-MAT / STAB-O-BLOC | seating comfort in any position

STAB-O-MAT and STAB-O-BLOC gas springs feature comfortable spring deflection properties across the entire adjustment range.

In the lowest seat position, the material and shape of the **end stop cushion** determine the spring comfort in standard gas springs.

Cushion as an end stop

Here, several versions are available:

- Several rubber cushions with 8 mm - 40 mm height are available
- Standardheight: 8 mm
- Polyurethane foam cushion

And to provide even more pampered seating comfort, STABILUS offers different solutions, such as

- integrated end position cushioning
- comfortable spring deflection properties and
- additional end position cushioning

Advantages:

- easy to actualise
- different versions
- attractive price

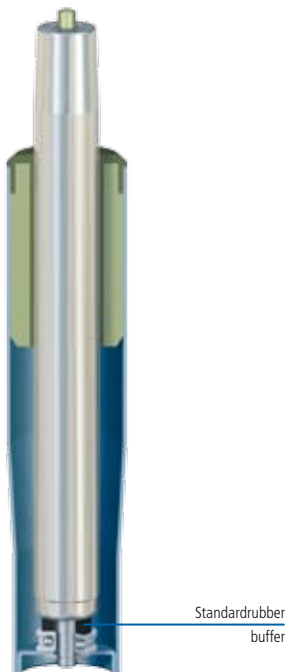

STAB-O-MAT / STAB-O-BLOC ID

| the column with integrated end position cushioning

An optimization of the spring characteristics in the lowest seat position can be achieved with the „integrated end position cushioning.“

The highly progressive force increase of the locked gas spring in the compressed position is improved due to a groove in the guide cylinder. Thus the swivel chair user feels the comfortable spring characteristics of the special end position cushion.

Advantages:

- improved spring properties in the lowest seat position
- attractive price

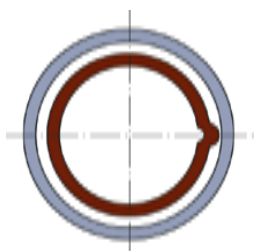
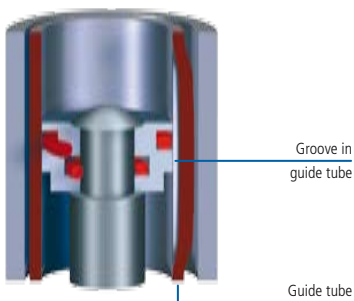
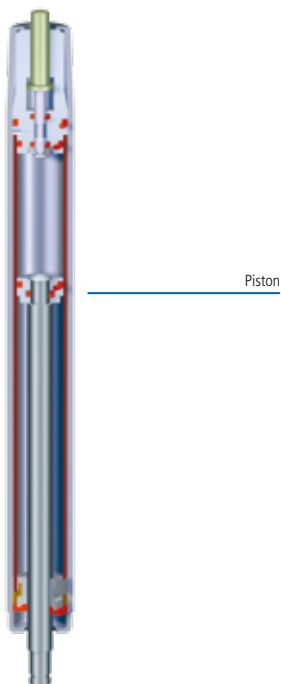

Tube cross-section

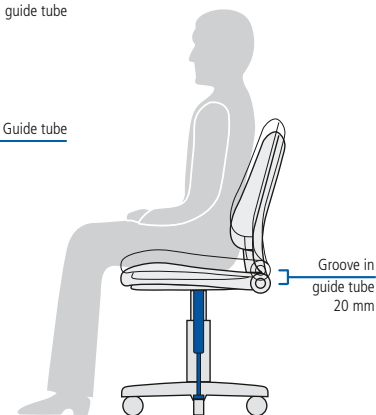

Spring function at lowest seat position ca. 20 mm

STAB-O-MAT / STAB-O-BLOC - CD | with highest comfort properties

In order to improve the spring comfort of the STABILUS standard height adjustment, we offer the STAB-O-BLOC with **highest comfortable spring deflection properties** across the entire stroke. This solution does not require additional installation space or additional parts.

In the lowest seat position, the comfortable spring deflection is damped progressively with a special end position cushion.

Advantages:

- more spring comfort across the entire stroke
- favorable comfort/price ratio



Piston

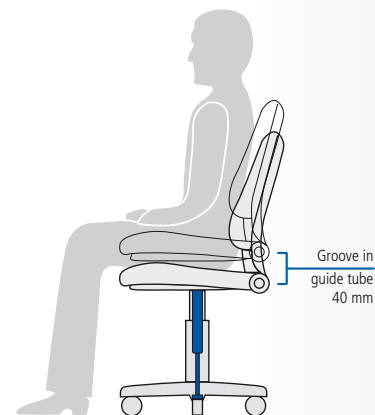

Groove in
guide tube
40 mm

STAB-O-MAT / STAB-O-BLOC - AD | with mechanical end position cushioning

Special seating comfort can be achieved with an additional compression spring in the outer tube. This spring is connected to the piston rod of the gas spring via flexible coupling.

When the piston rod is compressed, the compression spring performs the **additional end position cushioning** in the column.

In all stroke positions, the gas spring and the compression spring work together, which offers especially comfortable and soft spring characteristics when the gas spring is locked.

Advantages:

- high level of comfort across the entire stroke and in the lowest seat position

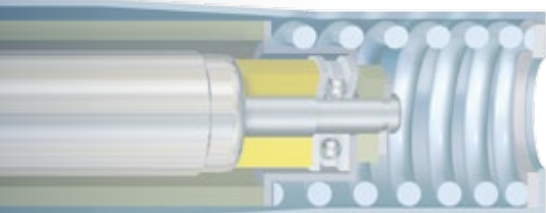
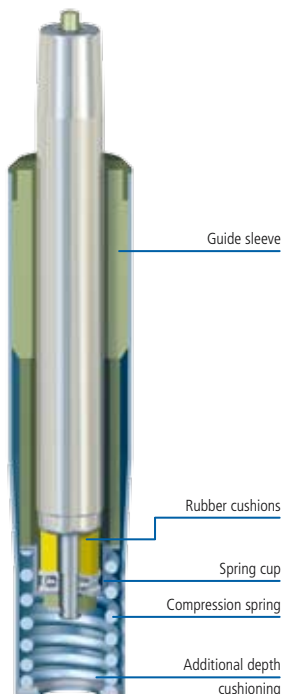

STAB-O-MAT / STAB-O-BLOC - TT

| the column with telescopic outer tube

The height adjustability of STAB-O-MAT and STAB-O-BLOC gas springs depends directly on the guide length and therefore the length of the outer tube. An increased adjustment range inevitably results in a longer outer tube and thus in a higher lowest seat position.

The STABILUS **telescopic outer tube** overcomes this effect with an additional telescopic tube. This solution provides a large adjustment range with a low bottom seat position without compromising stability and guide properties.

Advantages:

- large adjustment range at a low minimal height
- full comfort

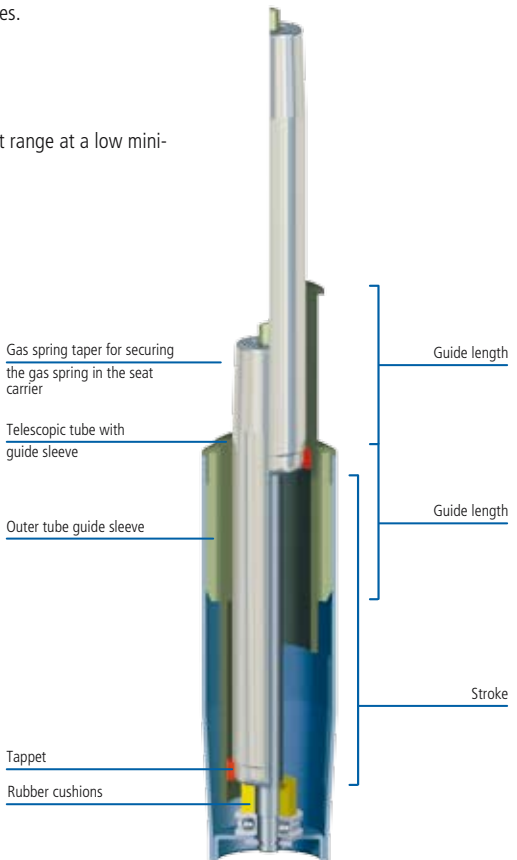

STAB-O-MAT / STAB-O-BLOC- SR | the swivel resistant column

Sometimes, swivel chairs should not turn, either due to the situations they are used in or because of the workplace design. The **swivel resistant column** ensures this.

Of course, all other advantages and the full comfort of the variable locking functions of the STAB-O-MAT and STAB-O-BLOC columns are available.

Advantages:

- for special workplaces without swivel function
- full comfort

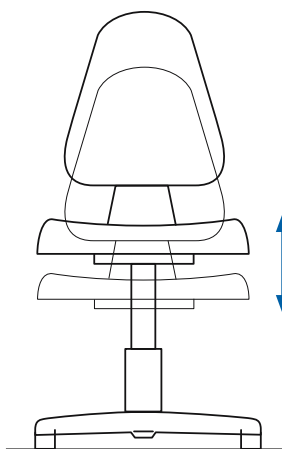
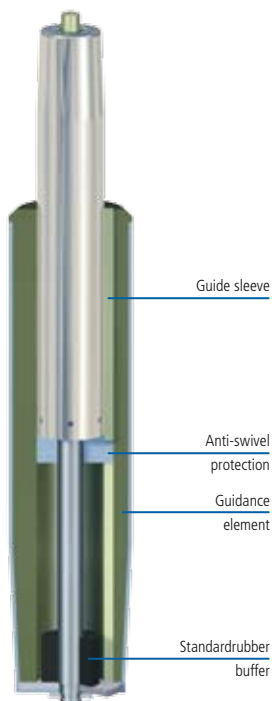

Non-swivelling

STAB-O-MAT - MC

| the multi-functional column

In some applications, such as in the object area, it is desirable that swivel chairs return to a certain position upon removal of the load.

The **multi-functional column** does exactly this: first, it returns to the highest seat position and then it turns automatically into the home position.

This ensures an appearance of „neatness“ at all times. Naturally, all other functions, as well as the comfort of variable seat adjustment, are still available in the **multi-functional column**.

Advantages:

- automatically returns to the home position
- full comfort

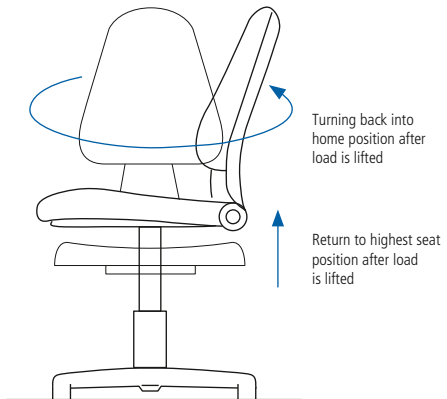
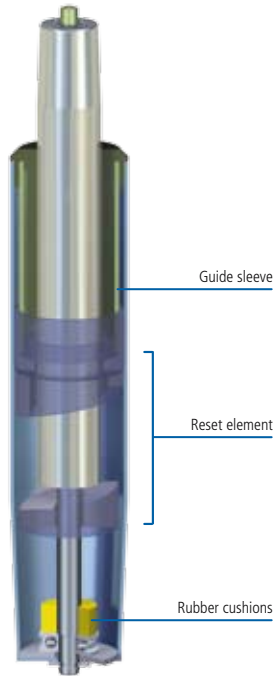

STAB-O-BLOC - SF | the column with stop function

To give a combined seating/standing task chair the required safety in the upper adjustment range and the desired comfort in the lower seat positions, STABILUS offers the telescope column with **stroke controlled stop function**.

Above a defined actuation point, a rubber stopper springs out of the column when a load is applied, thus preventing the chair from rolling away. Below this actuation point, the chair can be used normally.

Advantages:

- for combined seating/standing task chairs
- easy to implement
- no additional brakes required

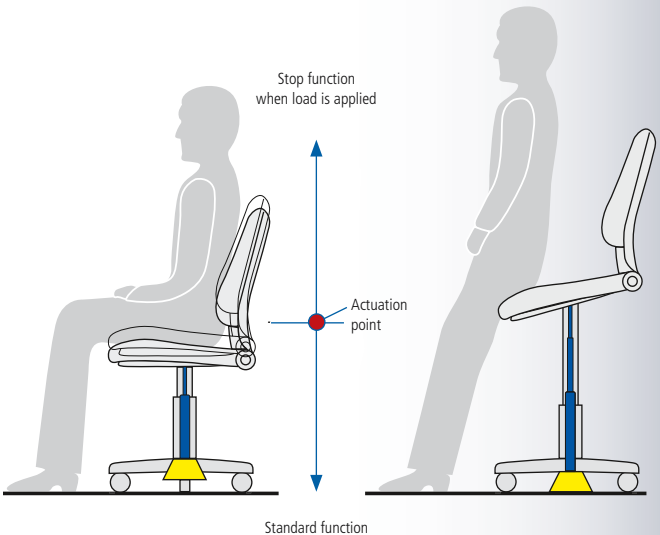
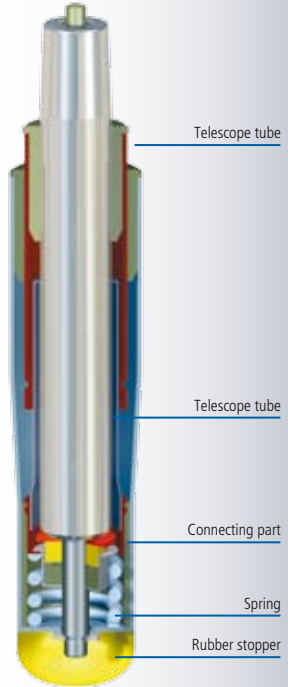

BLOC-O-LIFT Gas Spring | general

The BLOC-O-LIFT gas springs are so-called locking gas springs. They are used for functions such as adjustments with force support, damping, as well as infinitely variable locking. This is achieved with a special piston valve system. If the valve is open, BLOC-O-LIFT provides force support and damping. If the valve is closed, the gas spring locks and provides high resistance to any motion.

Basically, there are two types of valve design: a sliding valve with standard actuation of 2.5 mm, and the seat valve with an actuation of 1 mm for extremely short actuation distances.

BLOC-O-LIFT can have spring or rigid locking. The rigid locking version is available as orientation-specific or non-orientation specific.

Primary application areas for BLOC-O-LIFT gas springs are backrest and seat adjustment.

Advantage:

- numerous sizes and force variants
- linear spring characteristics for evenly low force increase across the entire range of movement
- suited for continuous actuation , for example for dynamic seating

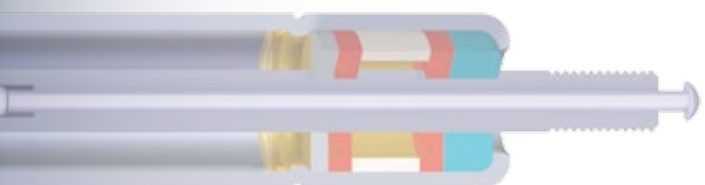
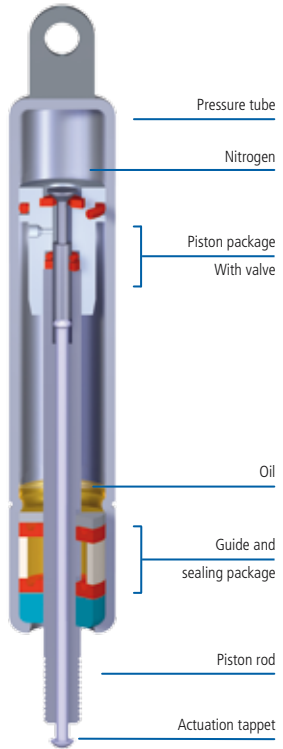

BLOC-O-LIFT

| rigid, locking, can be mounted in any orientation

Unlike the purely gas-filled BLOC-O-LIFT, where the gas characteristics cause spring locking, in this type of BLOC-O-LIFT, the entire working range of the piston is filled with oil. Depending on the installation of so-called separating pistons, which separate the gas chamber from the oil chamber, different locking forces can be achieved in the extension or compression directions. The maximum allowable locking force depends on the extension force and/or the overall device strength.

Specific advantages:

- Very high oil locking force
- Can be installed in any orientation

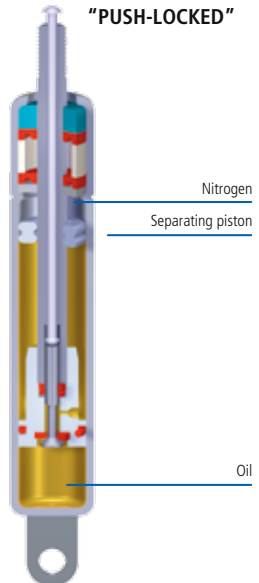
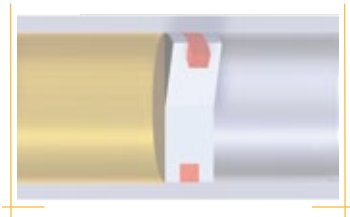
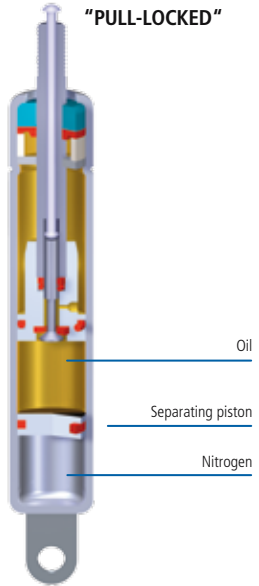

BLOC-O-LIFT | rigid locking, vertical installation

In this version of rigid locking gas springs, the entire working range of the piston is in oil, resulting in rigid locking, since oil cannot be compressed. Unlike the orientation-independent BLOC-O-LIFT, separating pistons were foregone in favor of lower costs. Flawless function is maintained by gravity; therefore, vertical or almost vertical installation must be ensured.

Here, the alignment of the piston rod defines the locking behavior in the pull or push direction.

Same **areas of application** as for the BLOC-O-LIFT described before.

Advantage:

- Cost-effective
- very high oil locking force

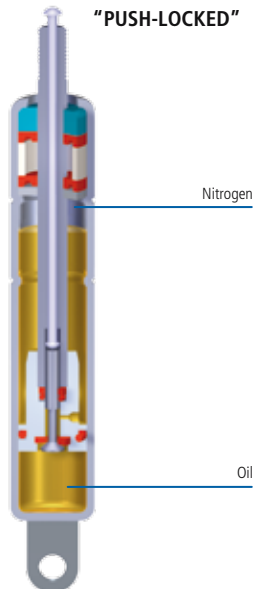
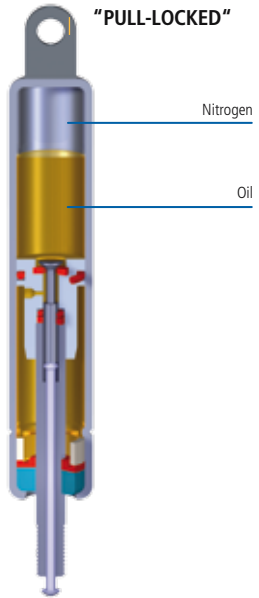

BLOC-O-LIFT | with release-stop

A problem that results from this is that if the backrest-lever is released while the seat-back is reclined and unstressed, the seatback jumps forward rapidly into the upright position, possibly hitting the user in the back.

BLOC-O-LIFT with release-stop is the solution to this problem. An on-off valve in the gas spring prevents any adjustment of the backrest unless the back itself is under load. Leaning on the back releases the on-off valve, allowing the backrest to follow the user. When this force is undetected, the backrest remains locked in its position.

Advantage:

- high ergonomomy by permanent body contact
- no rapid jump forward of the backrest

Adjustment possible only under load

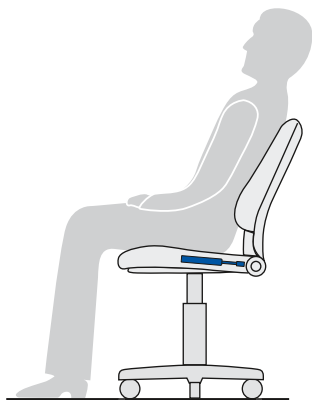
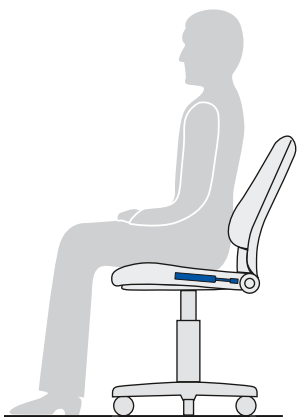

BLOC-O-LIFT | with override-function

A special form of this BLOC-O-LIFT gas spring is the additional override function. This function, which was designed for special customer requests, is to protect the application from overload.

The override function is available for tension and compression direction; it can be realised in locking gas springs featuring orientation-independent or vertical installation. The override force can be freely defined within certain limits.

The BLOC-O-LIFT override function is used for backrest and seat tilt function of swivel chairs.

Specific advantage:

- Overload protection

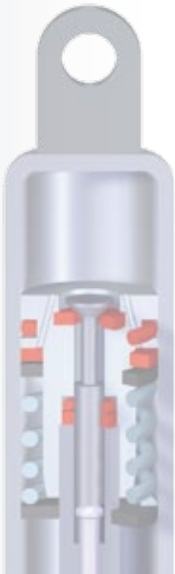
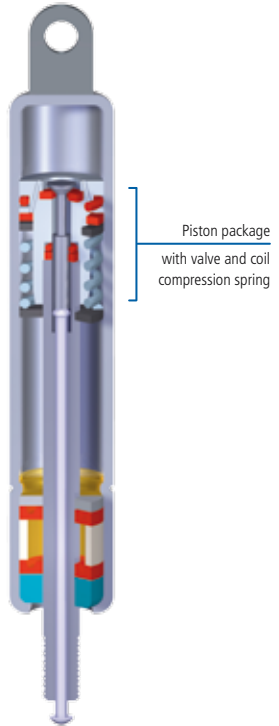

ACTUATION SYSTEMS

BLOC-O-LIFT actuation systems | for backrest and seat inclination

Stabilus offers different actuation systems for the BLOC-O-LIFT gas spring.

Different release heads with lever are available for applications with direct actuation of the gas spring.

Bowden cables are used for indirect actuation, i.e., not on the gas spring itself. This system consists of a release head, a Bowden cable and the actuation unit.

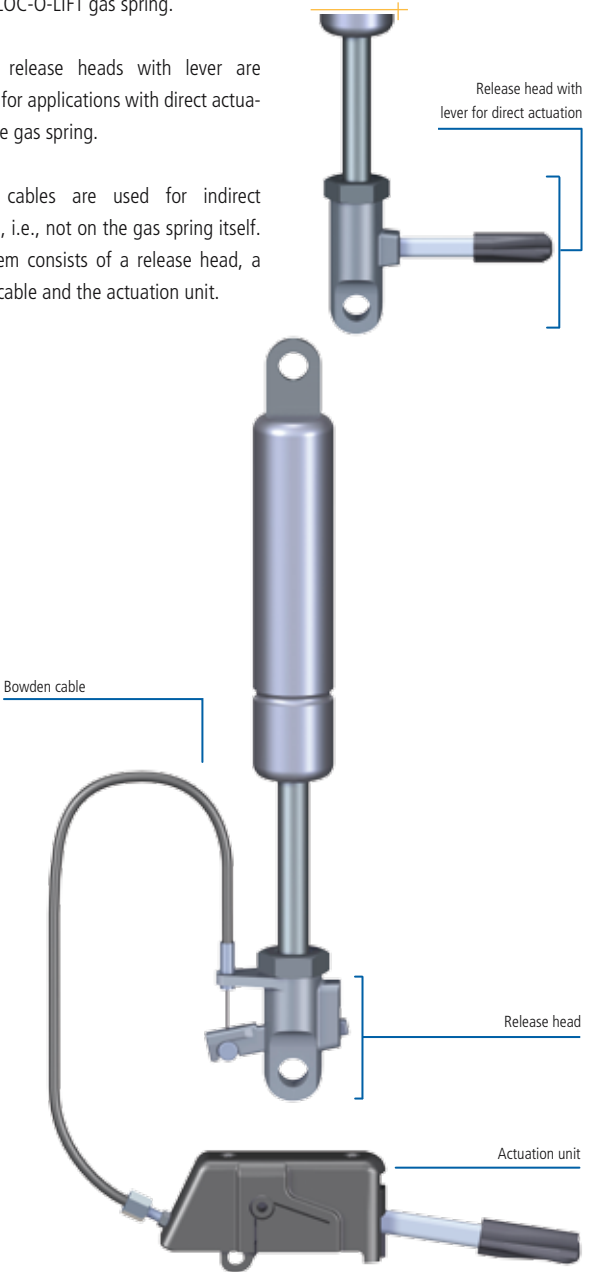

STAB-O-MAT / STAB-O-BLOC Actuation Systems | for height adjustments

Axial actuation (standard)

Actuation by axial operation of a plastic tappet is the standard for height adjustments.

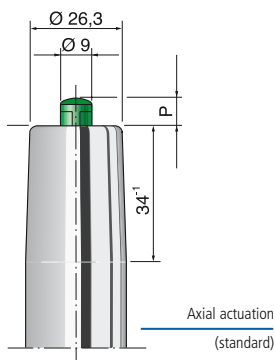

Axial actuation (with adjustment screw)

By inserting a screw in the plastic tappet, the protrusion and thus, the actuation point in the lever can be precisely defined.

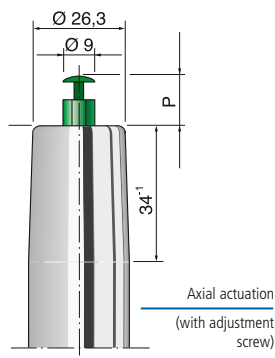

Axial actuation (valve seat in taper)

Moving the valve seat into the gas spring taper maximizes the stroke. The actuation mechanism acts axially, directly on the valve pin.

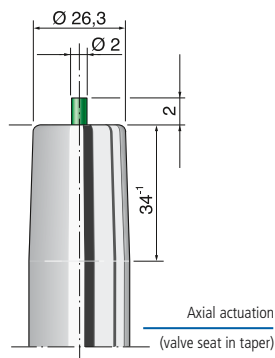

P = different measures selectable

Radial joystick actuation

In this variation, actuation is sideways in any direction, as well as from above. This function provides highly flexible actuation and saves space at the same time.

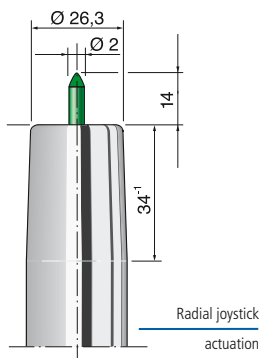

Axial Bowden cable actuation

The easy-to-install axial Bowden cable actuation provides maximum flexibility for moving the actuation mechanism.

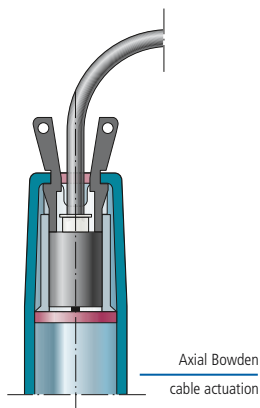

Radial Bowden cable actuation (fixed or rotatable 360°)

In radial actuation systems, the fixed radial Bowden cable actuation is the standard. The turning version of the radial Bowden cable actuation ensures tension-free installation. Furthermore, exact alignment of the gas spring during installation is no longer necessary.

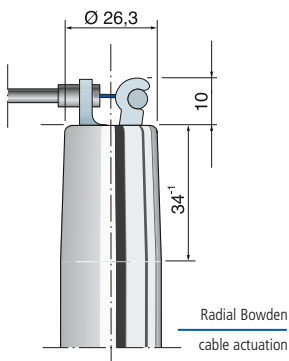

Individual Solutions for Many Applications

With its gas springs and hydraulic vibration dampers, STABILUS is the world market leader with an annual production of more than 120 million units.

By now, the range of applications for STABILUS products is nearly unlimited. In many areas, STABILUS products make everyday life easier and simply more comfortable.

STABILUS is known for technical innovation, quality, and competitive pricing. Of course, individual, extensive consultation and support with installation in the application can be taken for granted with STABILUS.

The STABILUS application consultants and technicians will work out optimised solutions for you and will be glad to fine-tune them with you on-site.

Stabilus GmbH
Wallerseimer Weg 100
56070 Koblenz
Germany
Telephone: ++49-261-8900-0
Fax: ++49-261-8900-204
E-Mail: info@de.stabilus.com

www.stabilus.de